

PEER – Development of Next Generation Liquefaction (NGL) Database for Liquefaction-Induced Lateral Spread

Research Team

- University of Utah, Steven Bartlett
- University of Washington, Steven Kramer
- Brigham Young University, Kevin Franke
- NOAA, Daniel Gillins (Consultant)



IMAGINE  THE UNIVERSITY OF UTAH®



 UNIVERSITY of WASHINGTON

Types of Liquefaction Damage

Power poles are pulled over by their wires as they can't be supported in the liquefied ground. Underground cables are pulled apart.

Lateral Spreading

River banks move toward each other. Cracks open along the banks. Cracking can extend back into properties, damaging houses.

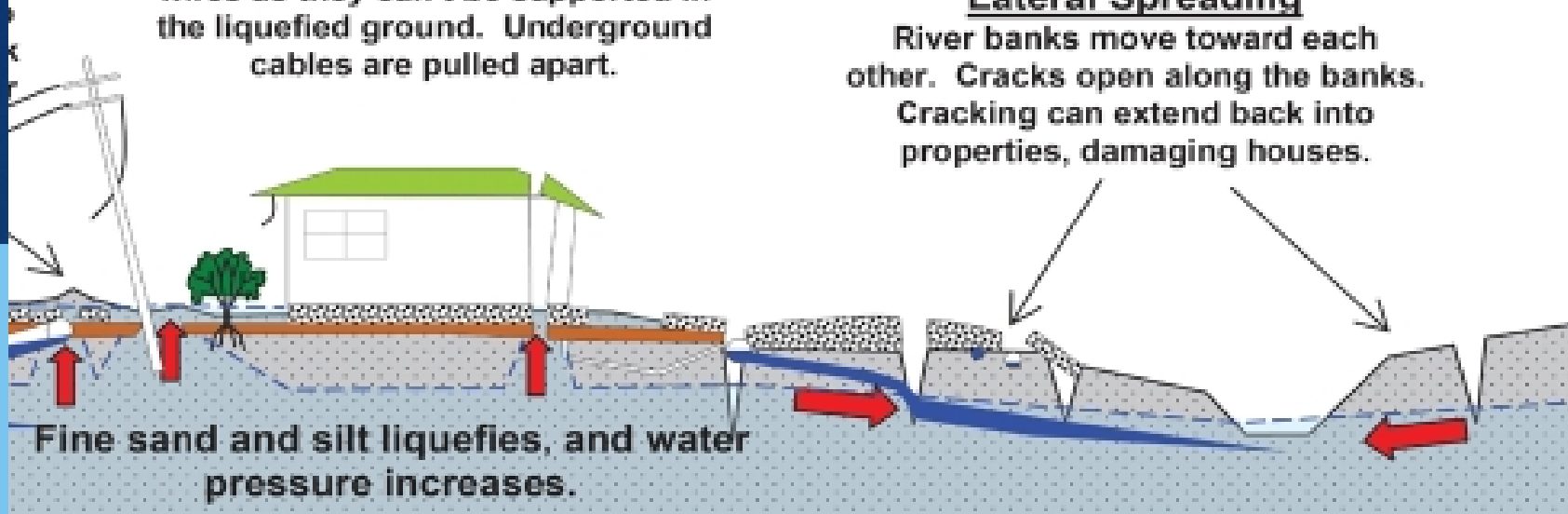

Lateral Spread



1964 Niigata, Japan Earthquake

Pacific Earthquake Engineering Research Center (PEER) – Next Generation Liquefaction (NGL) Project

1. substantially **improve** the quality, transparency, and accessibility of **case history data** related to ground failure;
2. provide a **coordinated framework** for supporting studies to **augment case history** data for conditions important for applications but poorly represented in empirical databases;
3. provide an **open, collaborative process for model development** in which developer teams have access to common resources and share ideas and results during model development, so as to reduce the potential for mistakes and to mutually benefit from best practices.

Development of NGL Database for Liquefaction-Induced Lateral Spread

Transportation Pooled Fund Program

Home | About TPF | How to Participate | Open Solicitations | Search | Forms | Success Stories | Related Links | Email Alerts

Home > Open Solicitations > Solicitation Detail View

Solicitation Detail View

Development of Next Generation Liquefaction (NGL) Database for Liquefaction-Induced Lateral Spread

General Information

Solicitation Number: 1405	Status: Solicitation posted	Date Posted: Jul 21, 2015
Last Updated: Oct 6, 2015	Solicitation Expires: Jul 21, 2016	Partners: UT
Lead Agency: Utah Department of Transportation		

Contact Information:

Lead Agency Contact:
David Stevens
davidstevens@utah.gov
Phone: 801-589-8340

FHWA Technical Liaison(s):
Justice Maswoswe
Justice.Maswoswe@dot.gov
Phone: 410-962-2460

Financial Summary:

Tools
Contacts
FAQs
Glossary

7:34 AM

<http://www.pooledfund.org/Details/Solicitation/1405>

Outcomes

- ❑ Produce a vetted and community database of seismic, topographical, geotechnical and horizontal displacement measurements pertaining to case histories of liquefaction-induced lateral spread for further research and model development by other researchers and investigators under the auspices of the Pacific Earthquake Engineering Research (PEER) Center. (COVERED BY THIS WORKPLAN)
- ❑ Update, validate and improve current empirical, semi-empirical, analytical and numerical methods using a peer-reviewed, community database of well-documented case histories of liquefaction-induced lateral spread. (FUTURE – NOT COVERED BY THE PRESENT PROJECT WORKPLAN)

Project Objectives

1. Develop peer-reviewed and consistent methodology for data documentation and archiving of lateral spread case histories.
2. Develop quality assurance protocols for assessing and documenting data quality.
3. Develop methods and/or protocols to quantify uncertainties associated with the collected data.
4. Populate the case history database with well-documented examples of liquefaction-induced lateral spread.
5. Review screening criterion used in evaluating lateral spread potential.
6. Disseminate the database for general use using web-based software

Tasks

1. Procurement of software and kickoff meeting
2. Development of data quality indicators/metrics, quality assurance and database population protocols.
3. Defining methods for quantifying uncertainty of key inputs
4. Development and structuring of database
5. Selection of case histories
6. Obtaining and screening of case history information
7. Population of case history database
8. Reporting and Database Dissemination
9. Review and Development of Screening Criteria for Lateral Spread Potential (NOT FUNDED)

Types of Data

- SEISMOLOGICAL FACTORS
- GEOLOGICAL FACTORS
- TOPGRAPHICAL FACTORS
- GEOTECHNICAL / SOIL FACTORS
- DAMAGE AND DISPLACEMENT MEAUREMENTS

Types of Data

- SEISMOLOGICAL FACTORS

Earthquake Name and Year
Earthquake Magnitude, Mw
Location
Source Distance Measures, Rrup, Rjb, etc.
Peak Ground Acceleration
Other measures of intensity (MMI, spectral accelerations, etc.
Duration
Nearby accelerogram (if available)

Types of Data - Source Maps

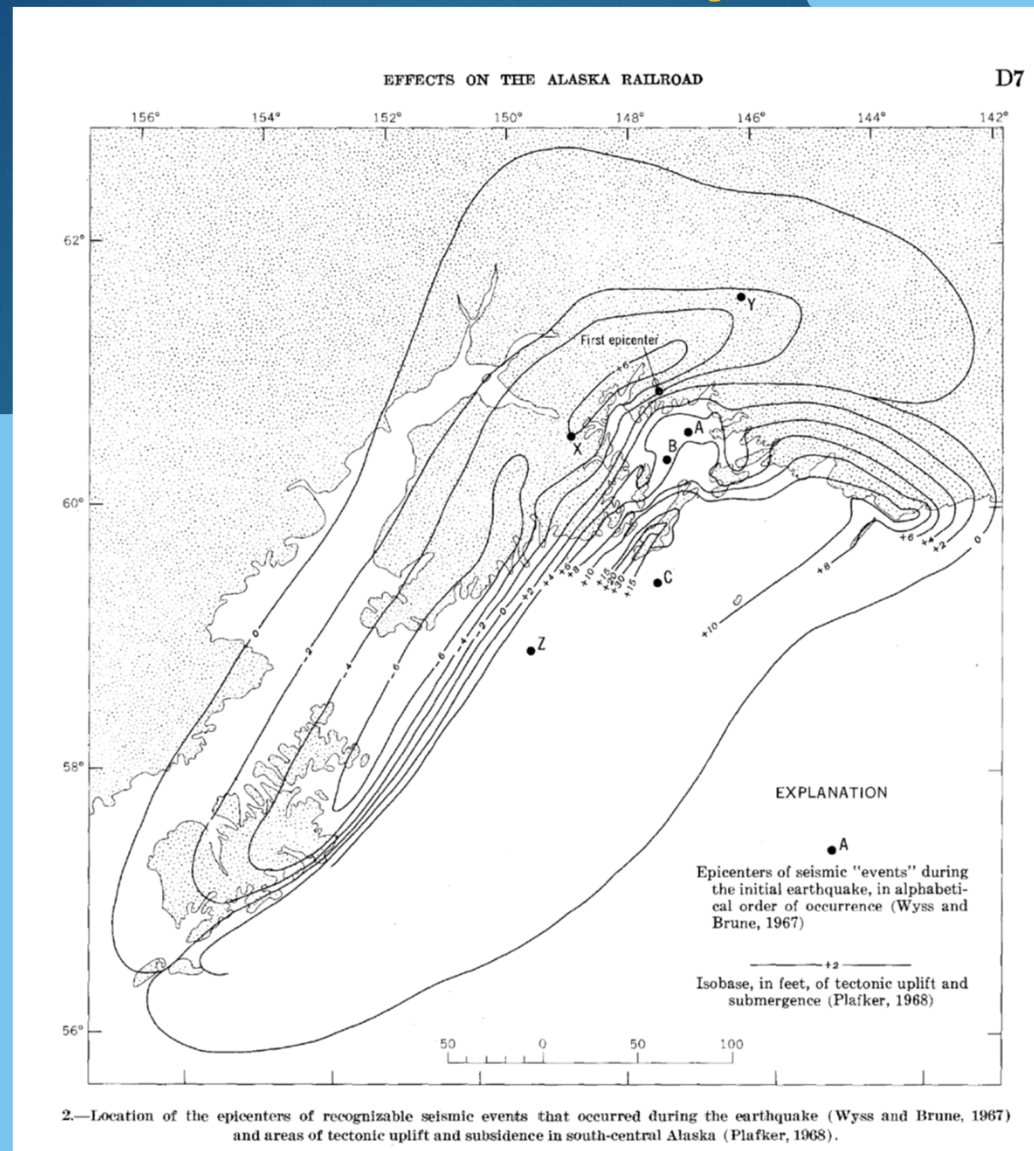

Epicenters and Crustal Warping - 1964 Alaska Earthquake

Types of Data - Strong Ground Motion Map

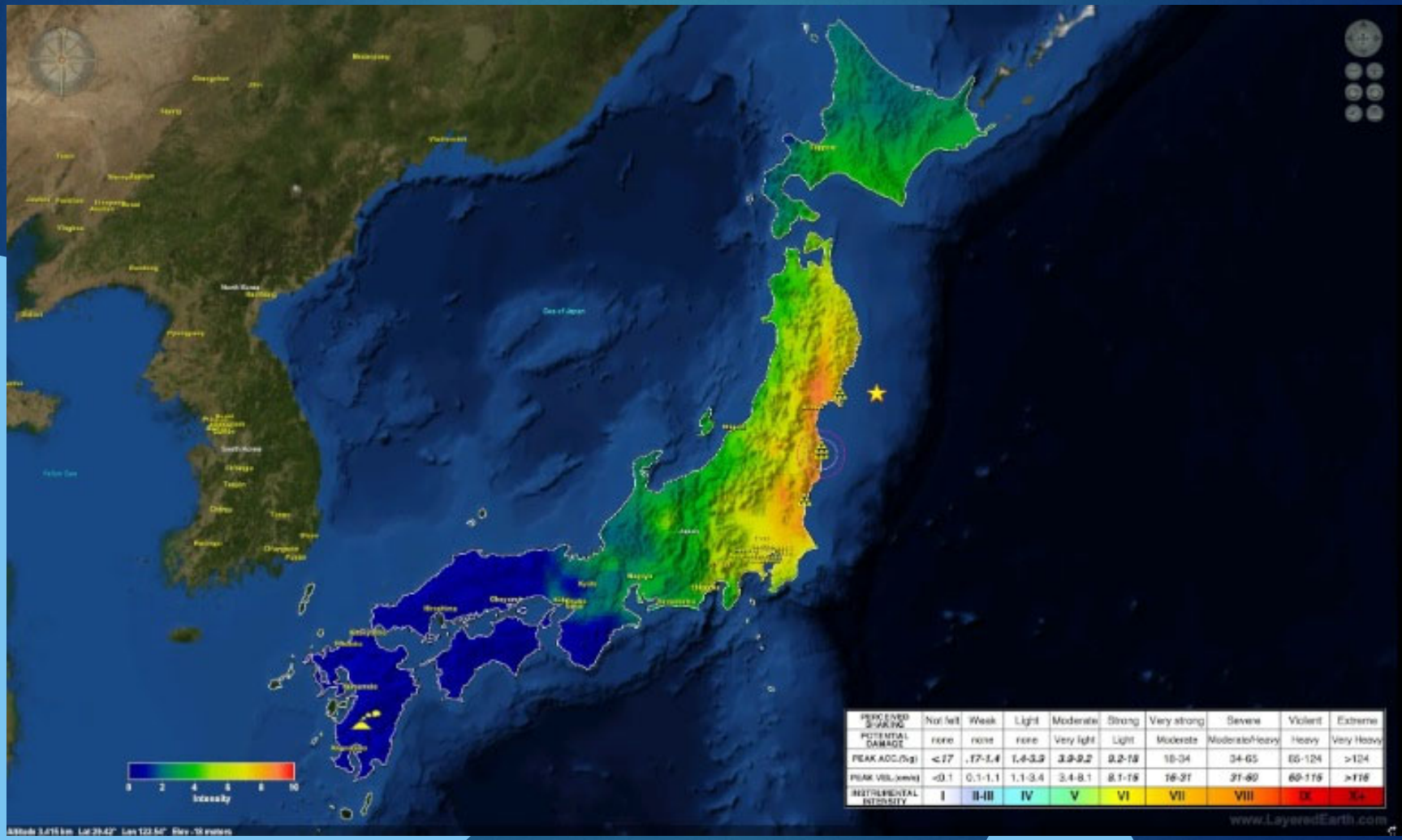

2011 Honshu Earthquake

Types of Data - Strong Ground Motion Records

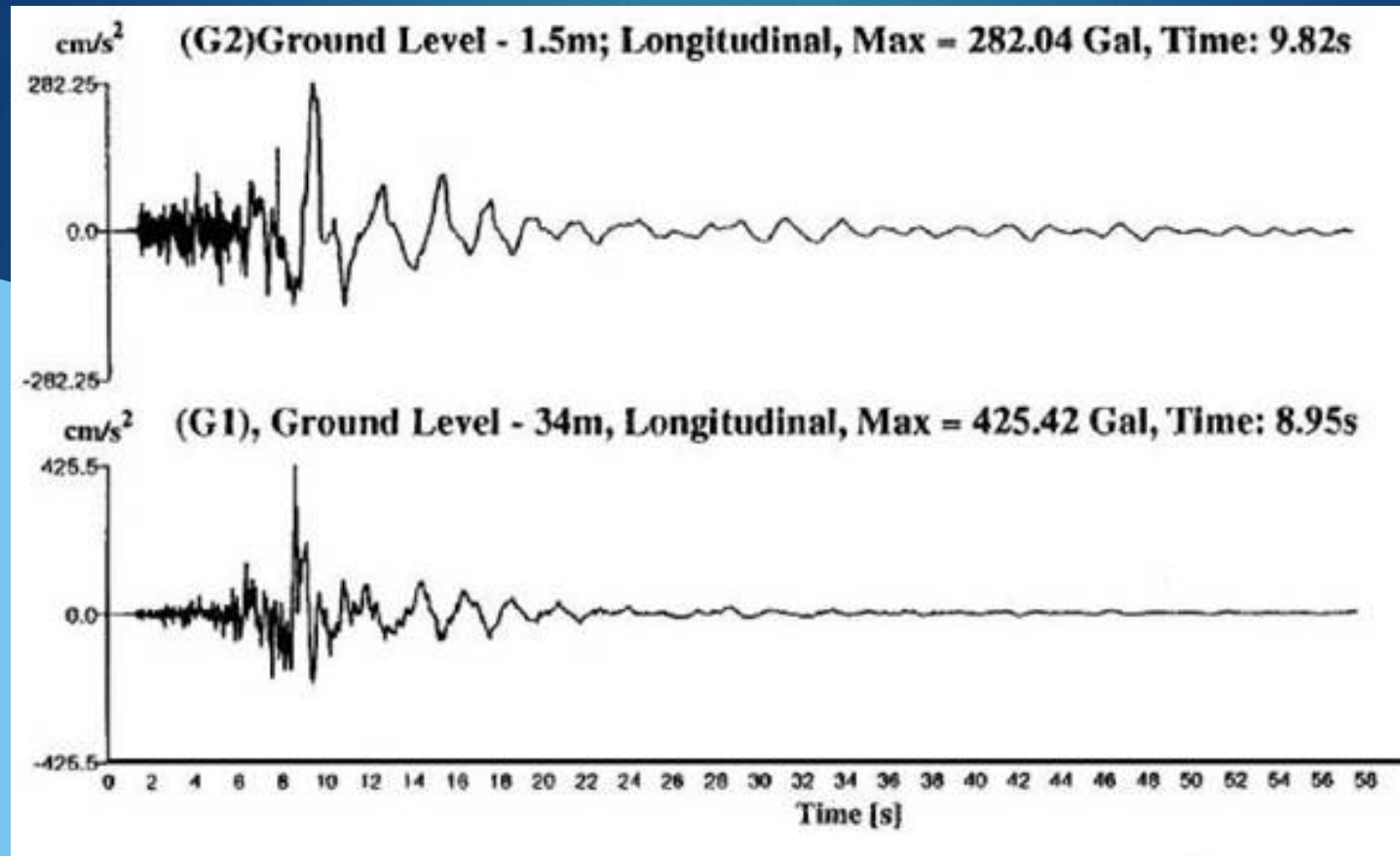

1964 Niigata Japan Earthquake

Types of Data

- GEOLOGICAL FACTORS

Geological unit and type of sediments
Age of sediments
Depth to groundwater
Geological map (if available)

Types of Data

- GEOLOGIC MAP

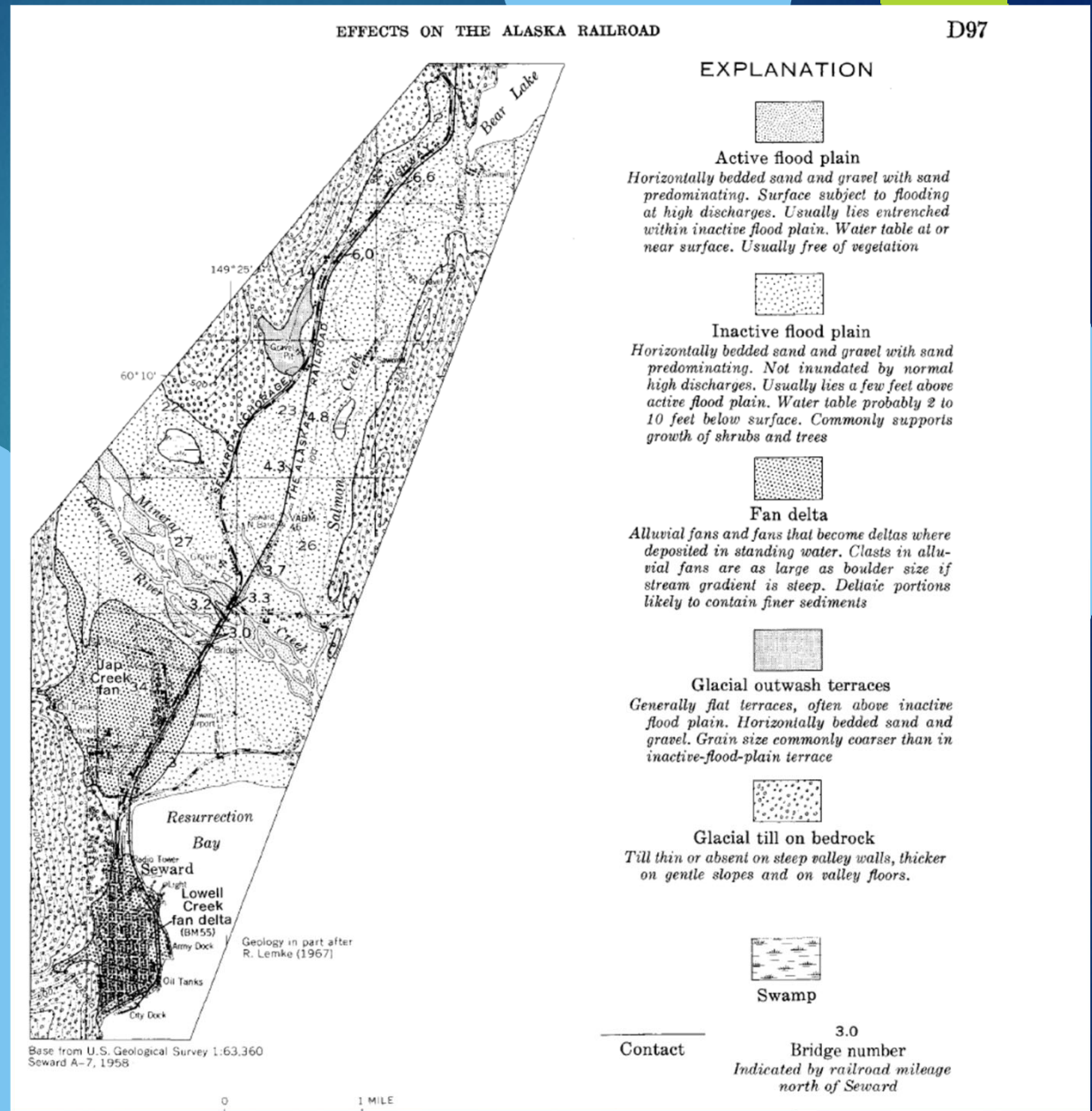

Types of Data

- TOPGRAPHICAL FACTORS
 - Topographical maps and/or Digital Elevation Model

Types of Data - Photos and Topographical Maps

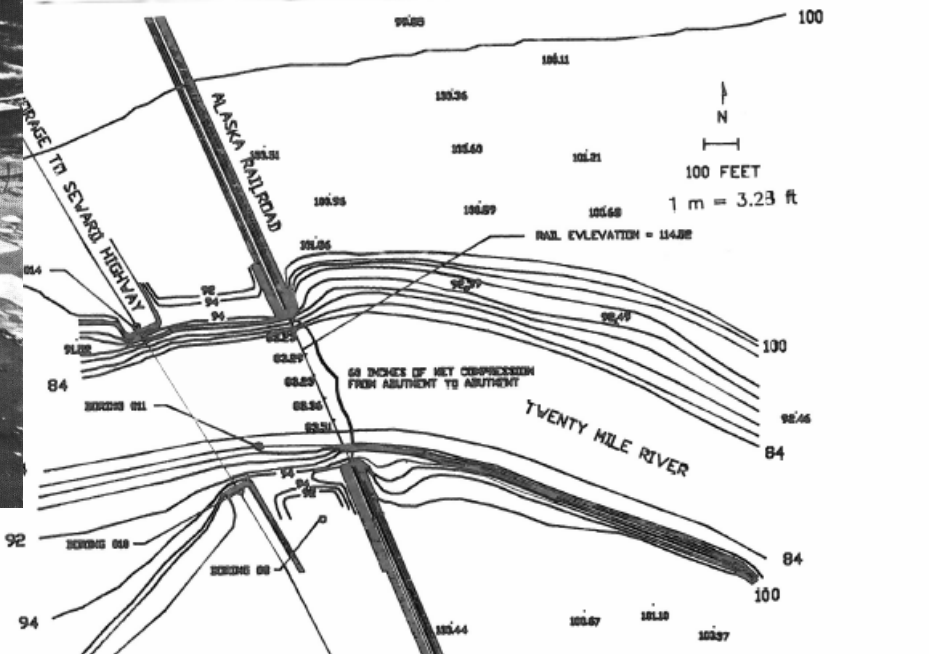
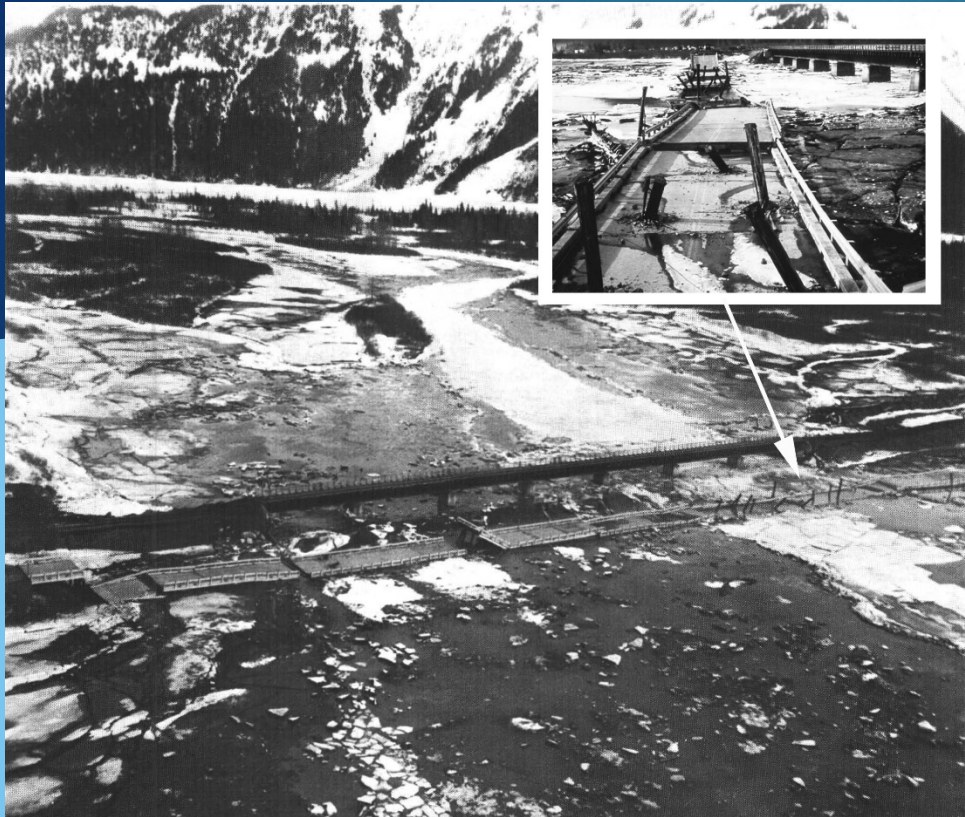

1964 Alaska
Earthquake

TOPOGRAPHY AT RAILROAD BRIDGE MP 64.7
TWENTY MILE RIVER, ALASKA
ELEVATIONS REFERENCED FROM AN ARBITRARY
DATUM, CONTOUR INTERVAL = 2 FEET
SURVEY AND INTERPRETED BY:
S. BARTLETT, S. McMULLIN, T.L. YOUNG,
BRIGHAM YOUNG UNIVERSITY, 1989

Types of Data

- GEOTECHNICAL / SOIL FACTORS

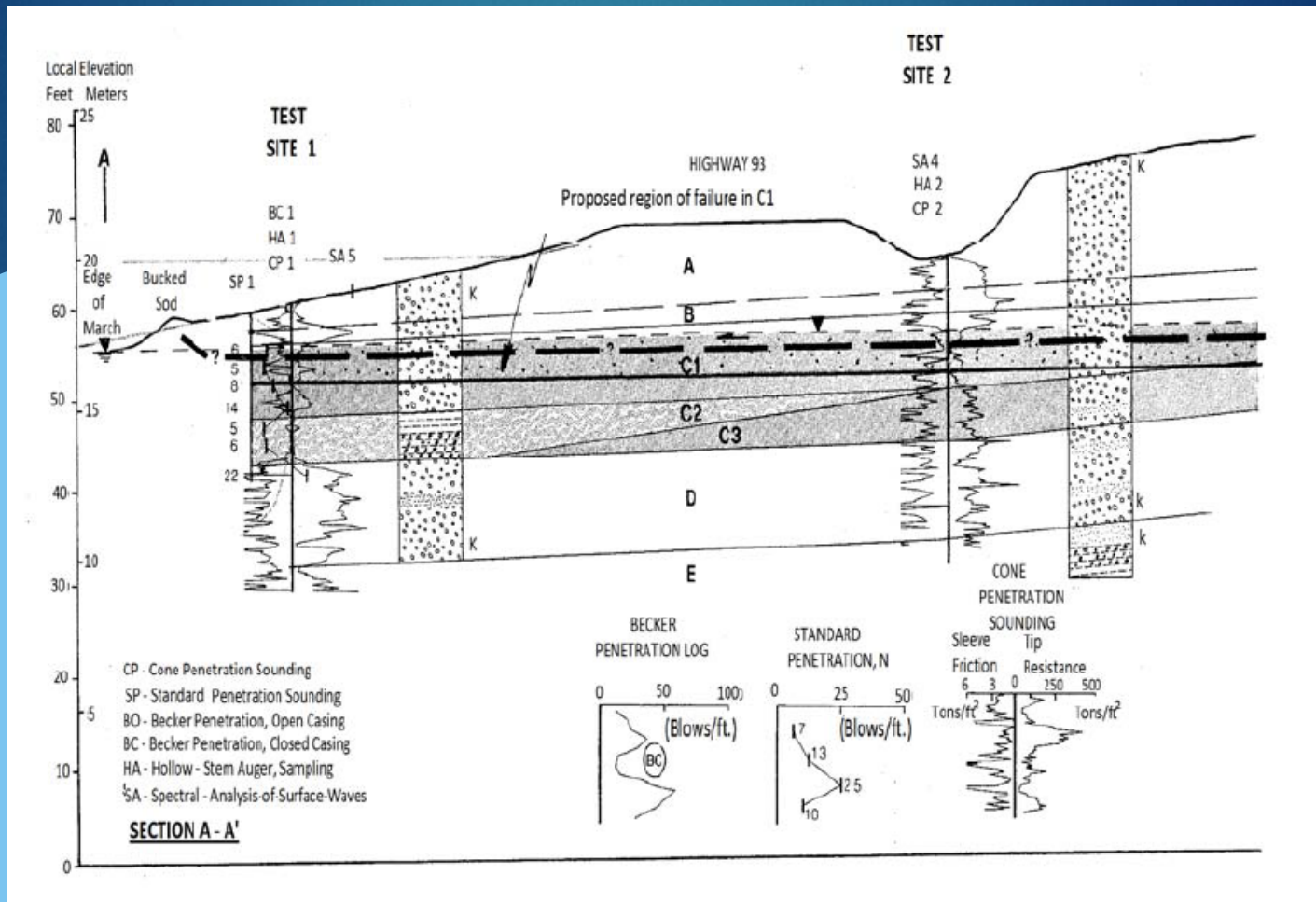

1983 Borah Peak Idaho Earthquake

Types of Data – Subsurface Data

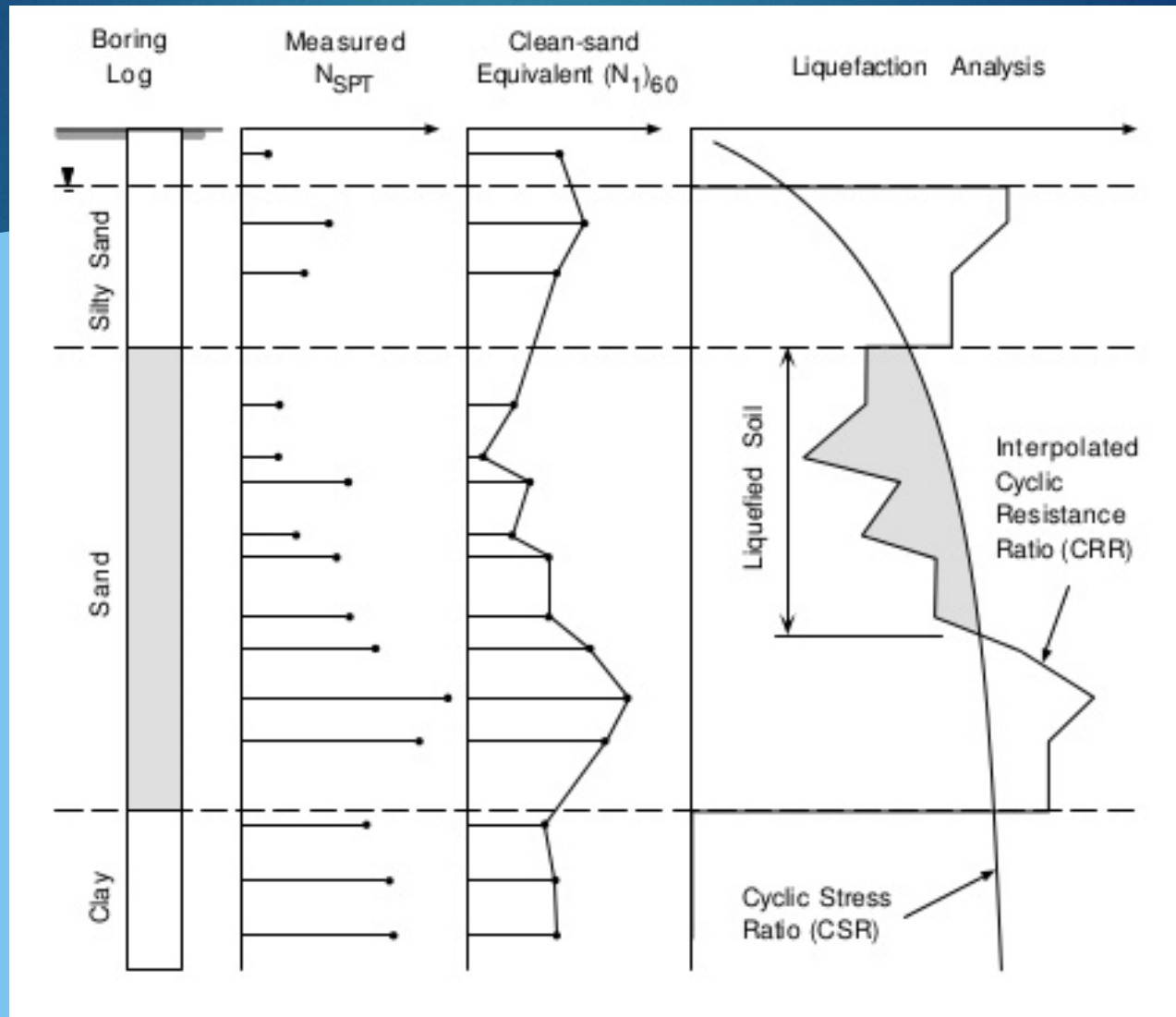

Types of Data - Aerial and Satellite Imagery

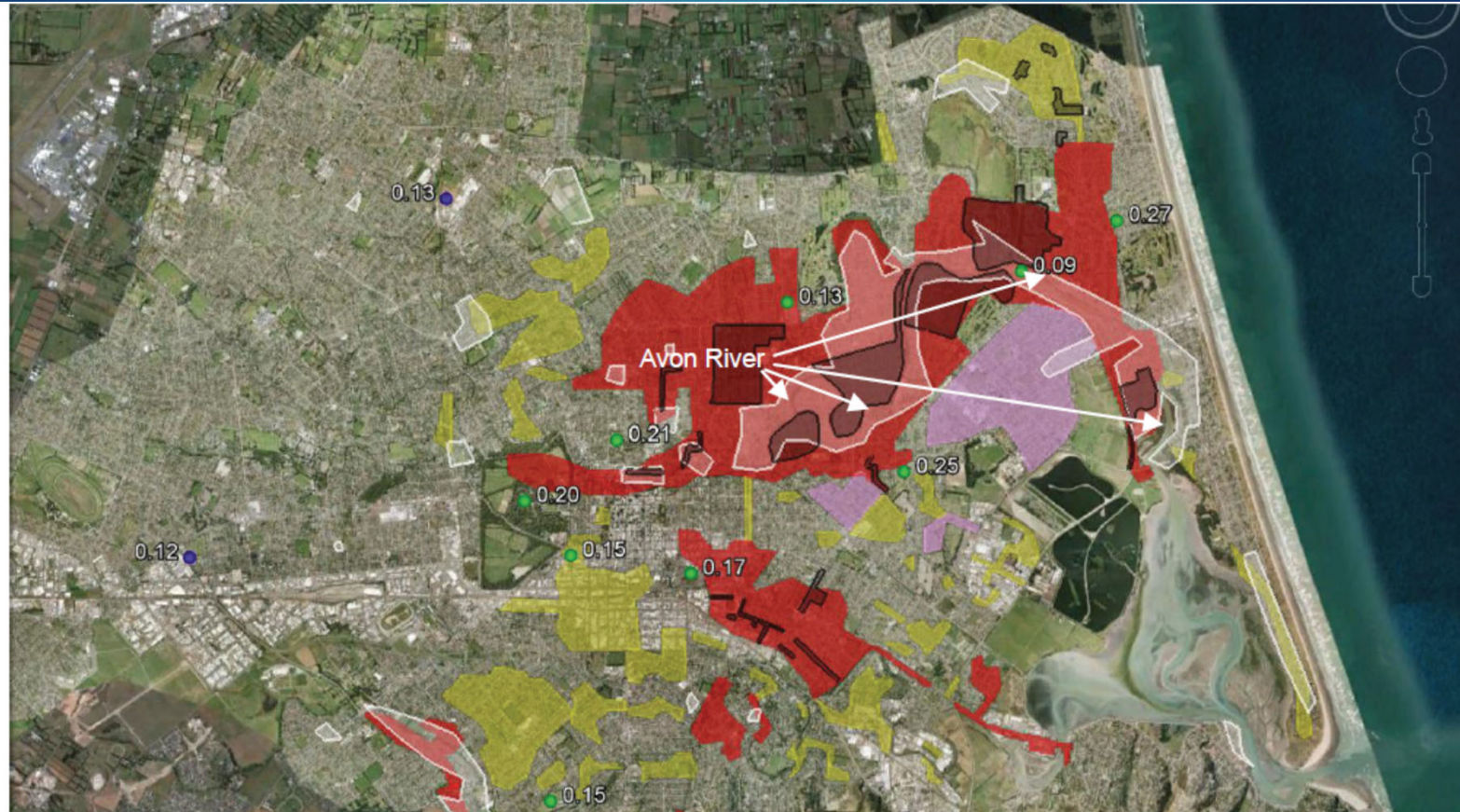

Fig. 4 Liquefaction maps indicating areas of observed liquefaction in the 4 September 2010 (white

2010 Christ Church Earthquake

Types of Data

- DAMAGE AND DISPLACEMENT MEASUREMENTS

1964 Niigata, Japan Earthquake

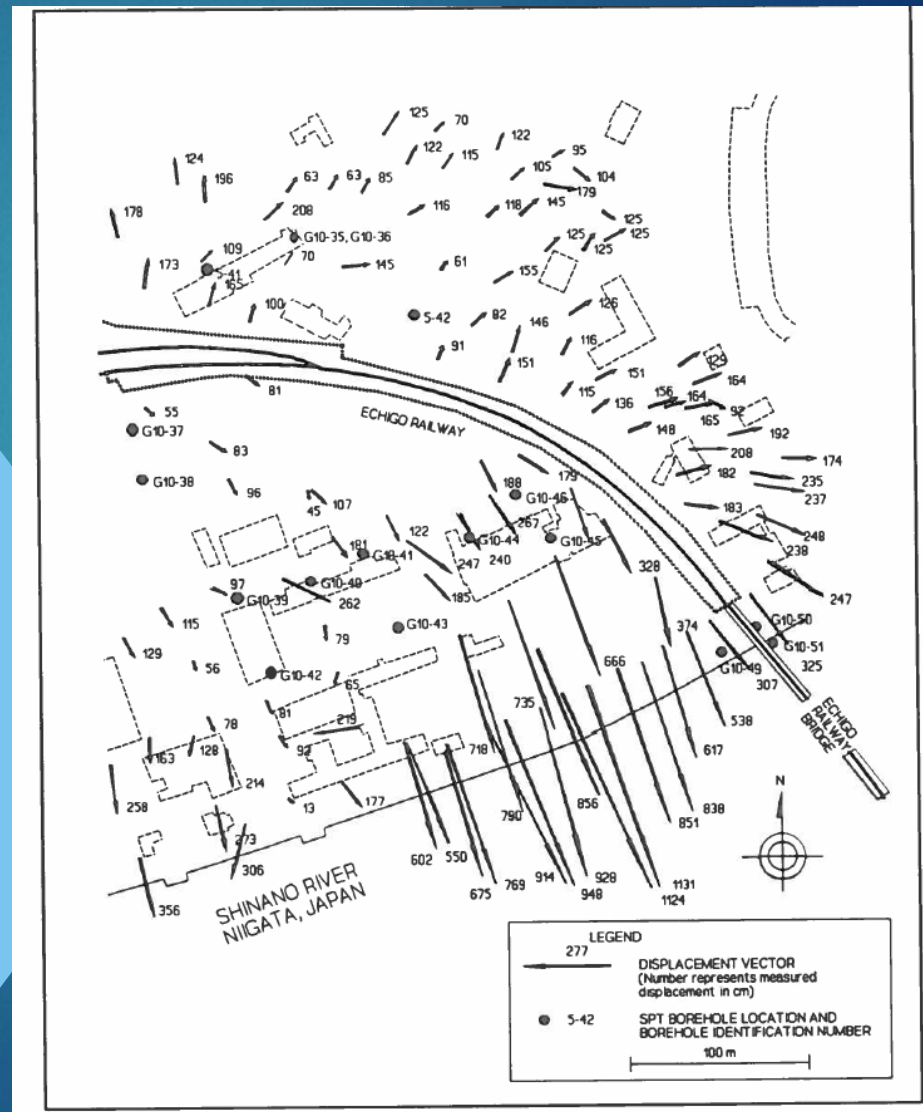

Types of Data - Interpretive Plots and Crack Maps

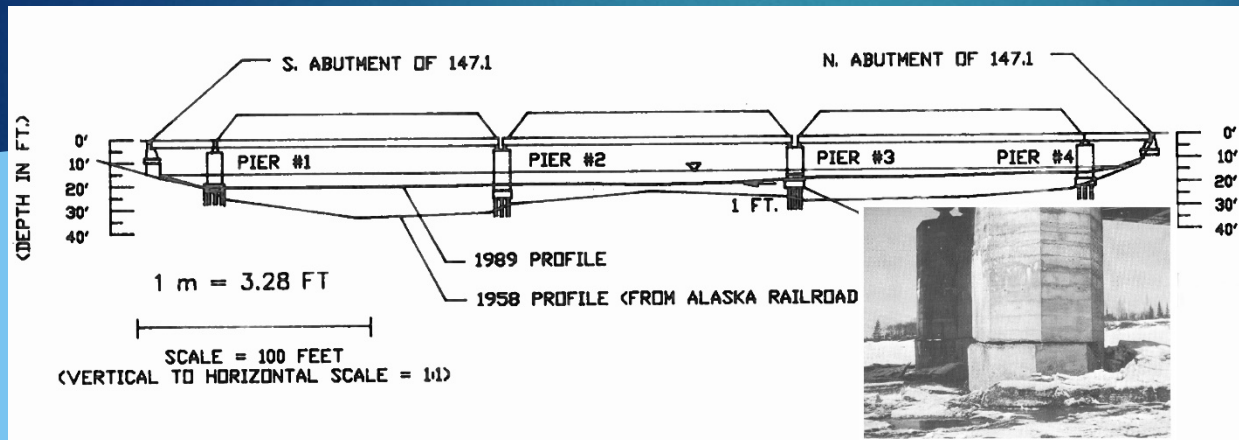

1964 Alaska
Earthquake

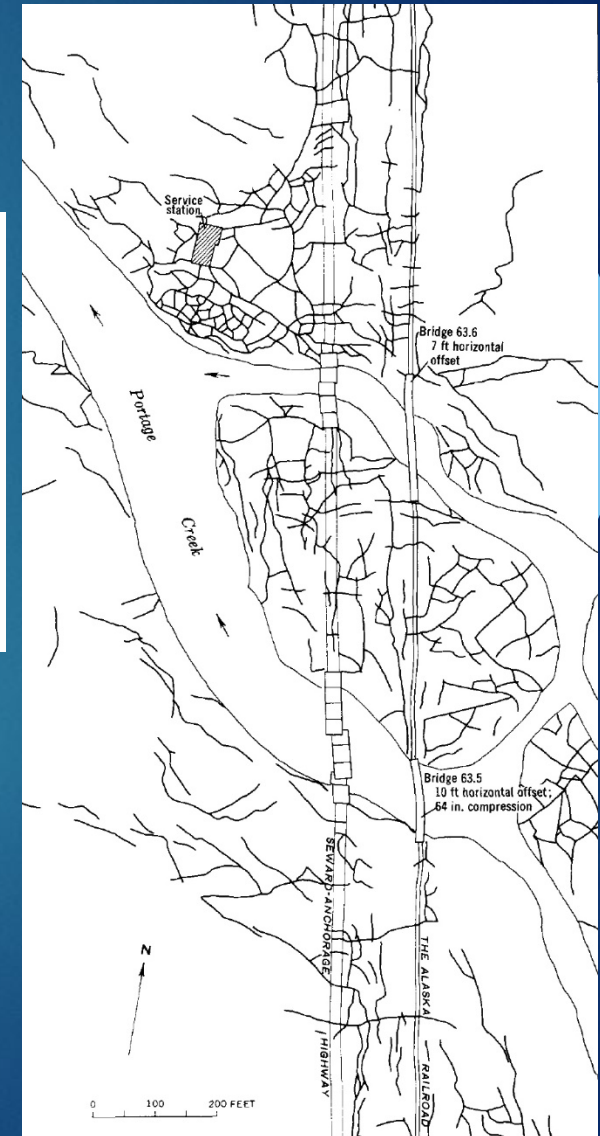

Relational Database Schema

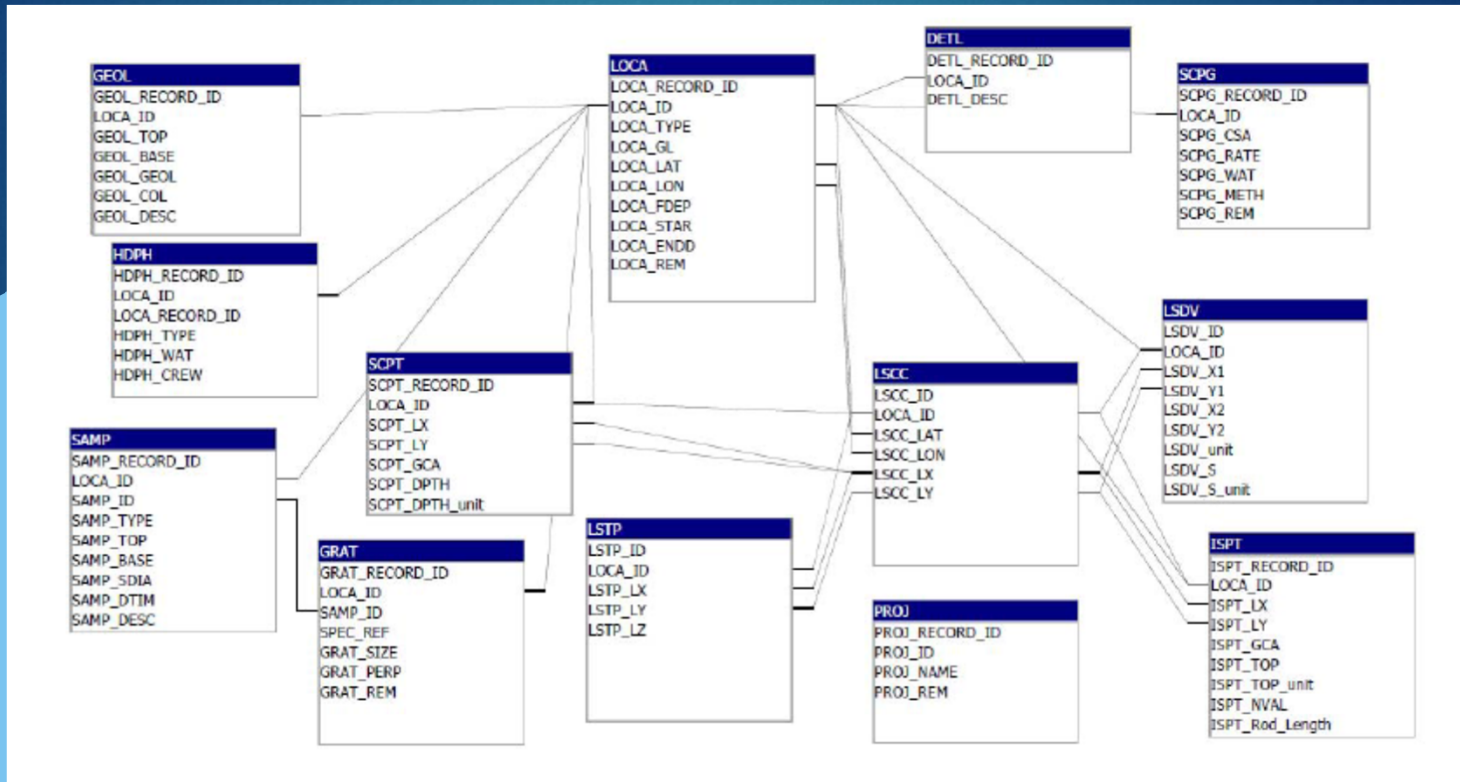

- Currently in Microsoft Access; could be translated into other database management systems such as MySQL
- Compatible with Electronic Transfer of Geotechnical and Geoenvironmental Data (AGS4) formatting
- Displacement vectors, bore logs, and topology with their spatial coordinates in database
- Other data as flatfiles (or Binary Large Objects, BLOBs)

Data Quality/Reliability Indicators

Sources of Error

Errors associated with digitizing data (our side);
minimized by cross-checking and following the data collection flowchart

Errors associated with the original data collection;
either reported or not reported

Data Collection Flow Chart

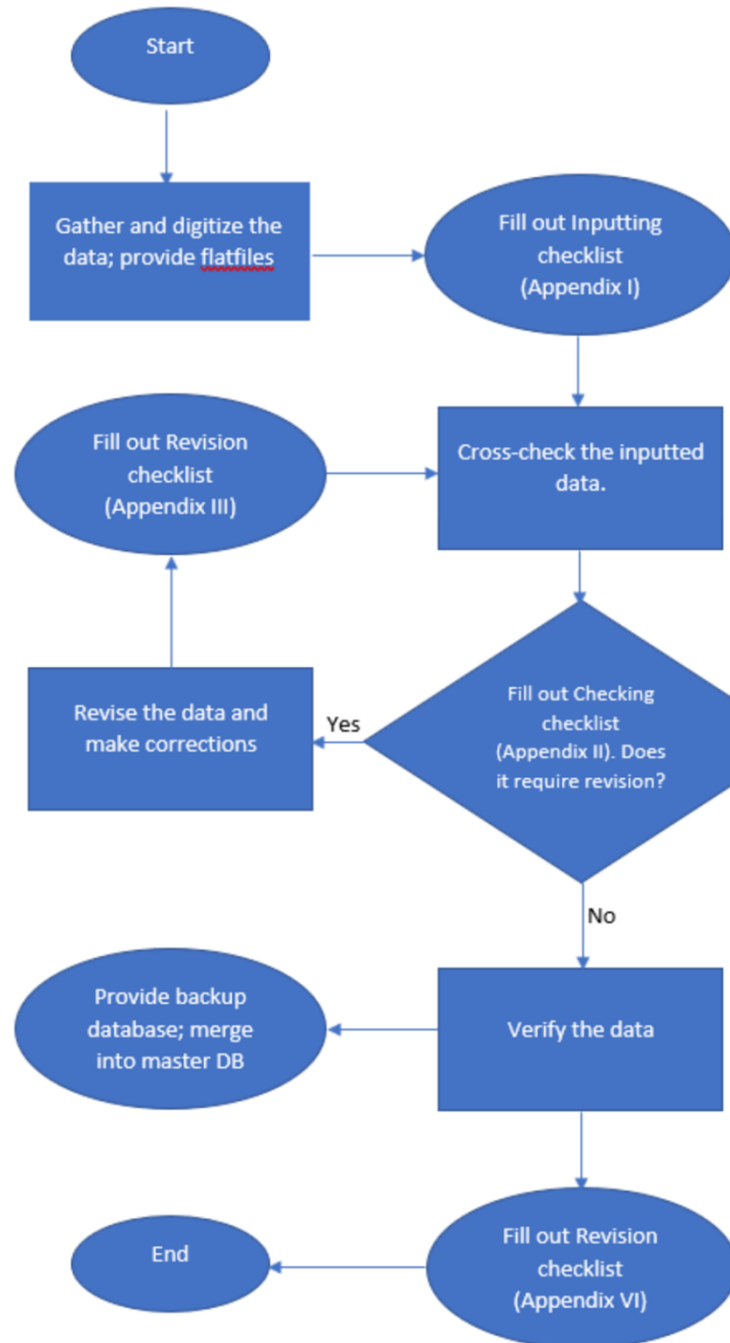

Data Quality/Reliability Indicators

Sources of Error

Errors associated with digitizing data (our side);
minimized by double-checking and following the data collection flowchart

Errors associated with the original data collection;
either reported or not reported

Data Quality/Reliability Indicators

Types of error within the second source of error

Data Accuracy. positional errors in extracting displacement vectors from aerial photographs.

Consistency and validity . Is this data consistent or in conflict with other reports (from other authors) at the same site?

Completeness. i.e. identifying & handling missing data; mostly in bore logs (gwt, hammer energy ratio, fines content, etc.).

Data Quality/Reliability Indicators

Field Name	Description	Indicator type
BoreDiam_ES	1 = directly from log; 2= from log drilled by same rig and driller; 3= unknown borehole diameter	Completeness
Elev_ES	1 = directly from log; 2 = estimated from nearby logs; 3 = from maps; 4 = unknown	Completeness
GWT_ES	1 = directly from log at least 24 hours after drilling; 2 = from log but date not listed; 3 = from nearby log; 4 = not reported in log	Completeness
HAMMERTYPE_ES	1 = directly from report; 2 = from other reports; 3 = not reported	Completeness
latitude_ES	1 = directly from log; 2 = digitized from maps; 3 = digitized from maps of lesser quality; 4 = perceived from other data	Completeness
longitude_ES		
latitude_positional_error;	NR = not reported; measurements otherwise	Accuracy
longitude_positional_error	NR = not reported; measurements otherwise	Accuracy
displ_vector_magnitude_ES	0 = directly from map; 1 = measured from map;	Completeness
displ_vector_type	indicates if the vector is on the ground or on a building or bridge, etc.	Completeness
topol_type	indicates if the point is on the ground or on a building or bridge, etc.	Completeness

List of Case History

Table 2 – List of Case Histories for Database

1906 San Francisco, California Earthquake	Coyote Creek Bridge near Milpitas California
	Mission Creek Zone in San Francisco
	Salinas River Bridge, Salinas California
	South of Market Street Zone in San Francisco
1964 Alaska Earthquake	Bridges 141.1, 147.4, 147.5, 148.3 on Matanuska River, Alaska
	Bridges 63.0, 63.5 on Portage Creek Alaska
	Highway Bridge 629 Placer River, Alaska
	Bridge 605A, Snow River, Alaska
	Bridges, 3.0, 3.2, 3.3, Resurrection River, Alaska
1964 Niigata, Japan Earthquake	Numerous lateral spreads within Niigata City
1971 San Fernando Earthquake	Jensen Filtration Plant, San Fernando, California
	Juvenile Hall, San Fernando, California
1979 Imperial Valley Earthquake	Heber Road near El Centro, California
	River Park near Brawley, California
1983 Borah Peak, Idaho Earthquake	Whiskey Springs near Mackay, Idaho
	Pence Ranch near Mackay, Idaho
1983 Nihonkai-Chubu, Japan Earthquake	Numerous lateral spreads within Noshiro City
1987 Superstition Hills, California Earthquake	Wildlife Instrumentation Array near Brawley, California
1989 Loma Prieta, California Earthquake	Pajaro River

List of Case History

Earthquake	
	Moss Landing, Monterey
	Marina District, San Francisco
1990 Luzon Philippines Earthquake	Dagupan City
1991 Costa Rica Earthquake	Railroad and Highway Bridge sites
1994 Northridge, California Earthquake	King Harbor, Redondo Beach
	Balboa Blvd., San Fernando Valley
	Malden Street, San Fernando Valley
	Wynne Avenue, San Fernando Valley
	Potrero Canyon, San Fernando Valley
1995 Kobe, Japan Earthquake	Lateral Spreads on Port Island
	Lateral Spreads on Roko Island
1999 Kocaeli, Turkey Earthquake	Cark Canal Site
	Yakin Street Site
	Cumhuriyet Avenue Site
	Sapanca Hotel Site
	Police Station Site, East Izmit Bay
	Soccer Field Site, East Izmit Bay
	Degirmendere Nose Site
	Yalova Harbor Site
1999 Chi-Chi, Taiwan Earthquake	Wufeng Site C
	Wufeng Site C1
	Wufeng Site B
	Wufeng Site M
	Nantou Site N
	Leuw Mei Bridge
2010 Maule, Chile Earthquake	Port Coronel
	Valparaiso
	Llacolén Bridge
	Juan Pablo II Bridge, Concepcion
	La Mochita Bridge, Concepcion
	Tubul Bridge, Tubul
	Mataquito Bridge, Iloca
2011 Tohoku, Japan Earthquake	Several lateral spreads
2010 Darfield, New Zealand Earthquake	Several lateral spreads in and around Christchurch
2011 Christchurch, New Zealand Earthquake	Several lateral spreads in and around Christchurch

Data Population Progress

Case history	Site	Displacement vectors	Boreholes	Subsurface data (row)	Topology (points)
1964 Niigata	F10	179	24	359	429
	G10	585	68	1574	256
	H9	112	4	92	235
	J9	442	45	192	297
	K8	285	4	62	302
	Total	1603	145	2279	1519
1983 Noshiro	South	266	128	462	176
	North	147	59	848	348
	Total	413	187	1310	524
1971 San Fernando	Jensen water plant	69	33	494	flatfile
	Juvenile hall	79	6	121	flatfile
	Total	148	39	615	-
1964 Alaska	Total	14	20	411	flatfile
1979 Imperial valley	Heber road	in progress	3 (in progress)	54 (in progress)	in progress
	River park site	in progress	4	62	in progress
1983 Borah peak, Idaho	documents gathered, ready to digitize, in progress				
1906 San Francisco	documents gathered, ready to digitize, in progress				

Summary

- Lateral spread database must accommodate various data types that is spatially located
- Most case histories have value if the data quality and/or potential sources of uncertainty in the measurements can be quantified
 - Data quality ranking scheme
 - Uncertainty estimates or statistical distribution about estimates
- More information req'd
 - Vector displacement maps
 - Recordings of better estimates of strong motion
 - Large subduction zone earthquakes
 - Silty and gravelly soils
 - Affect of layer thickness
 - Aging effects